

# Panasonic

Proprietary Telephone

## Quick Reference Guide

Model No. **KX-T7735E**

### Important Information

---

Thank you for purchasing the Panasonic Proprietary Telephone, KX-T7735E.

**When using the KX-T7735E, keep the following conditions in mind.**

- If you are having problems making calls, unplug the extension line and connect a known working telephone. If the known working telephone operates properly, have the defective telephone repaired by an authorised Panasonic Factory Service Centre. If the known working telephone does not operate properly, check the KX-TE or KX-TDA series and the extension wiring.
- Keep the unit away from heating appliances and devices that generate electrical noise, such as fluorescent lamps, motors and televisions. These noise sources can interfere with the performance of the unit. This unit should be kept free of dust, moisture, high temperature (more than 40 °C) and vibration, and should not be exposed to direct sunlight.
- The apparatus is designed to be installed and operated under controlled conditions of ambient temperature and a relative humidity not greater than 60 %.
- Avoid installing the unit in damp or humid environments, such as bathrooms or swimming pools.
- Wipe the unit with a soft cloth. Do not clean the unit with abrasive powders or with chemical agents such as benzene or thinner.
- Use only the correct Panasonic handset.
- Do not disassemble this product. Dangerous electrical shock could result. The unit must only be disassembled and repaired by qualified service technicians.
- When a failure occurs which exposes any internal parts, disconnect the telephone line cord immediately and return the unit to a service centre.
- Never attempt to insert wires, pins, etc, into the vents or other holes of this unit.
- 999 and 112 can be on the apparatus after accessing the CO line for the purpose of making outgoing calls to the BT emergency (999) and (112) services.
- This apparatus is capable of being used in conjunction with hearing aids fitted with inductive coil pick-ups. The handset should be held as for normal conversation. For operation the hearing aid should be set to its "T" position or as directed in the operating instructions for the hearing aid.



#### **WARNING:**

TO PREVENT POSSIBLE FIRE OR ELECTRIC SHOCK, DO NOT EXPOSE THIS PRODUCT TO RAIN OR MOISTURE.

THIS HANDSET EARPIECE IS MAGNETISED AND MAY RETAIN SMALL FERROUS OBJECTS.







#### **IMPORTANT NOTICE:**































- Under power failure conditions, this telephone may not operate. Please ensure that a separate telephone, not dependent on local power, is available for emergency use in emergencies.

#### **Notes:**











- In this manual, the suffix of each model number is omitted.
- For further information, refer to the Main Unit/PABX Manuals.

# Features List













 Outside (CO) Line button    
  Programmable Feature button    
  Feature number  
 Off-hook    
  On-hook    
  Talk    
 \* "Location of Controls" is shown on page 8.

Desired Function	Operation	
<b>Making Calls</b>		
Calling	<p><b>To an extension</b></p>  ► <b>extension no.</b> ► 	<p><b>To an external party</b></p>  ►  ► <b>phone no.</b> ► 
Redial	 ►  ► 	
One-touch Dialling	<p><b>To program</b></p>  ►  <b>2</b> /  ► <b>phone no.</b> ►  ► 	
	<p><b>To dial</b></p>  ►  /  - assigned as a One-touch dialling button ► 	
Calling an operator	 ► <b>0</b> / <b>9</b> ► 	
Personal Speed Dialling	<p><b>To set</b></p>  ►  <input type="checkbox"/> KX-TE Series  <input type="checkbox"/> KX-TDA Series (Check the type of your Main Unit.)	<p><b>Personal speed dial no.</b> ►</p> <p>[TE: 0-9 TDA: 00-99 (Default: 00-09)]</p>
	<p>► <b>desired no.</b> ► <b>#</b> ► </p> <p>(TE: max. 24 digits) (TDA: max. 32 digits)</p>	<p><b>To dial</b></p>  ►  <input type="checkbox"/> KX-TE Series  ►  <input type="checkbox"/> KX-TDA Series (Check the type of your Main Unit.)
System Speed Dialling	<p><b>To dial</b></p>  ►  ► <b>System speed dial no.</b> ►  <p>[TE: 00-99 TDA: 000-999]</p>	





























# Features List

Desired Function	Operation
<b>Receiving Calls</b>	
Hands-free answerback	<p><i>While on-hook</i></p> <p><b>AUTO ANS</b>    <b>MUTE</b></p>
Picking up a call	<div style="border: 1px dashed black; padding: 10px;"> <p><b>Directed</b></p> <p> <input type="checkbox"/> 4 ▶ extension no. <input type="checkbox"/> KX-TE Series  <input type="checkbox"/> * 4 1 ▶ extension no. <input type="checkbox"/> KX-TDA Series         </p> <p><b>Group</b></p> <p> <input type="checkbox"/> 4 0 <input type="checkbox"/> KX-TE Series  <input type="checkbox"/> * 4 0 ▶ group no. <input type="checkbox"/> KX-TDA Series         </p> <p>(Check the type of your Main Unit.)</p> </div>
<b>When the Dialed Extension is Busy/No Answer</b>	
Automatic Callback Busy	<p><b>To set</b> <i>While hearing a busy tone</i></p> <p>6 ▶ </p> <p><b>To answer</b> <i>If you hear callback ringing</i></p> <p></p>
Message Waiting	<p><b>Sender</b></p> <p><b>To leave a notification</b></p> <p><b>MESSAGE</b>   ▶ </p> <hr/> <p><b>To cancel a notification</b></p> <p> <input type="checkbox"/> KX-TE Series          extension no. ▶ <b>MESSAGE</b>  ▶ <b>MESSAGE</b>  </p> <p> <input type="checkbox"/> KX-TDA Series          * 7 0 0 ▶ extension no.       </p> <p>(Check the type of your Main Unit.)</p>
	<p><b>Receiver</b></p> <p><b>To call back</b></p> <p> ▶ <b>MESSAGE</b>  ▶ </p> <hr/> <p><b>To clear all notifications</b></p> <p> <input type="checkbox"/> KX-TE Series          7 0 0 ▶ #       </p> <p> <input type="checkbox"/> KX-TDA Series          * 7 0 0 ▶ receiver's extension no.       </p> <p>(Check the type of your Main Unit.)</p>









# Features List

Desired Function	Operation	
<b>When the Dialed Extension is Busy/No Answer</b>		
<b>Call Waiting</b>	<b>Sender</b>	<p><i>While hearing a busy tone</i></p> <div style="border: 1px solid black; padding: 5px; display: inline-block;"> <input type="checkbox"/> <b>2</b> <input type="checkbox"/> KX-TE Series  <input type="checkbox"/> <b>1</b> <input type="checkbox"/> KX-TDA Series         </div> <p>▶ Wait for an answer. ▶ </p> <p>(Check the type of your Main Unit.)</p>
	<b>Receiver</b>	<div style="border: 1px dashed black; padding: 10px;"> <p><input type="checkbox"/> KX-TE Series</p> <p><b>For outside calls</b></p> <div style="border: 1px solid black; padding: 5px; display: inline-block;"> <input type="checkbox"/> <b>7 3 1 1 #</b> Set  <input type="checkbox"/> <b>7 3 1 0 #</b> Cancel         </div> <p><b>For intercom calls/doorphone calls</b></p> <div style="border: 1px solid black; padding: 5px; display: inline-block;"> <input type="checkbox"/> <b>7 3 2 1 #</b> Set  <input type="checkbox"/> <b>7 3 2 0 #</b> Cancel         </div> </div> <p style="text-align: center;"> ▶ <input type="checkbox"/> KX-TDA Series ▶ </p> <div style="border: 1px dashed black; padding: 10px;"> <p><b>For outside calls</b></p> <div style="border: 1px solid black; padding: 5px; display: inline-block;"> <input type="checkbox"/> <b>* 7 3 2 1</b> Set  <input type="checkbox"/> <b>* 7 3 2 0</b> Cancel         </div> <p><b>For intercom calls</b></p> <div style="border: 1px solid black; padding: 5px; display: inline-block;"> <input type="checkbox"/> <b>* 7 3 1 1</b> Set  <input type="checkbox"/> <b>* 7 3 1 0</b> Cancel         </div> </div> <p>(Check the type of your Main Unit.)</p>
<p><b>To talk to the new party (While hearing the Call Waiting tone)</b></p> <p><b>Terminating a current status :</b>  ▶  ▶ </p> <p><b>Holding a current status (outside call)</b>   ▶  /  ▶ </p> <p><b>Holding a current status (extension)</b>   ▶ </p>		

# Features List

Desired Function	Operation	
<b>During a Conversation</b>		
Holding a call	<b>Holding</b>  ► 	<b>To retrieve a call at the holding extension</b>  ►  /  ► 
	<b>To retrieve an outside call from another extension</b>  ►  ► 	
Holding a call exclusively	<b>Holding</b>  ►  ► 	<b>To retrieve a call on exclusive hold</b>  ►  /  ► 
Transferring a call	<b>TRANSFER</b>  ► <span style="border: 1px solid black; padding: 2px;">extension no.</span>  <span style="border: 1px solid black; padding: 2px;">phone no.</span>	to an extension to an external party ►  ►  Announce.
<b>Useful Features</b>		
Paging	<b>To page</b> <input type="checkbox"/> KX-TE Series <div style="border: 1px dashed black; padding: 5px; margin: 5px 0;"> <b>All extensions</b>  <span style="border: 1px solid black; padding: 2px;">3</span> <span style="border: 1px solid black; padding: 2px;">3</span> <span style="border: 1px solid black; padding: 2px;">0</span>  <b>Group</b>  <span style="border: 1px solid black; padding: 2px;">3</span> <span style="border: 1px solid black; padding: 2px;">3</span> <span style="border: 1px solid black; padding: 2px;">group no.</span>  <b>All external speakers</b>  <span style="border: 1px solid black; padding: 2px;">3</span> <span style="border: 1px solid black; padding: 2px;">4</span>  <b>All extensions &amp; external speakers</b>  <span style="border: 1px solid black; padding: 2px;">3</span> <span style="border: 1px solid black; padding: 2px;">3</span> <span style="border: 1px solid black; padding: 2px;">*</span> </div>  ►  Announce.	
	<input type="checkbox"/> KX-TDA Series  ► <span style="border: 1px solid black; padding: 2px;">*</span> <span style="border: 1px solid black; padding: 2px;">3</span> <span style="border: 1px solid black; padding: 2px;">3</span> <span style="border: 1px solid black; padding: 2px;">group no.</span> ►  Announce. <p>You can make a voice announcement to extensions or external speakers or both in the preset group simultaneously.</p> <b>To answer an announced page</b>  ► <div style="border: 1px dashed black; padding: 5px; margin: 5px 0;"> <b>Through a telephone speaker</b>  <span style="border: 1px solid black; padding: 2px;">4</span> <span style="border: 1px solid black; padding: 2px;">3</span> <input type="checkbox"/> KX-TE Series  <span style="border: 1px solid black; padding: 2px;">*</span> <span style="border: 1px solid black; padding: 2px;">4</span> <span style="border: 1px solid black; padding: 2px;">3</span> <input type="checkbox"/> KX-TDA Series           </div> ►  (Check the type of your Main Unit.)	
Three-party conference	<b>CONF</b>  ► <span style="border: 1px solid black; padding: 2px;">third party's no.</span> ►  ► 	

# Features List

Desired Function	Operation
<b>Useful Features</b>	
Setting Absent Message	 ▶ [ <input type="text" value="7"/> <input type="text" value="5"/> ▶ message no. <input type="checkbox"/> KX-TE Series ] [ <input type="text" value="*"/> <input type="text" value="7"/> <input type="text" value="5"/> <input type="text" value="0"/> ▶ message no. <input type="checkbox"/> KX-TDA Series ] (Check the type of your Main Unit.) ▶ <input type="text" value="parameter (if required)"/> ▶ <input type="text" value="#"/> ▶ 
Forwarding a call	<input type="checkbox"/> KX-TE Series  ▶  ▶ [ <b>All calls</b> <input type="text" value="1"/> ▶ extension no. ] <b>Busy/No answer</b> <input type="text" value="2"/> ▶ extension no. ] <b>To an outside line</b> <input type="text" value="3"/> ▶ line access code ▶ phone no. ▶ <input type="text" value="#"/> ▶  <b>Follow Me</b> <input type="text" value="5"/> ▶ your extension no. ] <b>Follow Me Cancel</b> <input type="text" value="8"/> ▶ your extension no. ] <b>Cancel</b> <input type="text" value="0"/> ] <input type="checkbox"/> KX-TDA Series  ▶ <input type="text" value="*"/> <input type="text" value="7"/> <input type="text" value="1"/> [ <input type="text" value="0"/> Both calls <input type="text" value="1"/> Outside calls ▶ <input type="text" value="2"/> Intercom calls ] ▶ [ <b>All calls</b> <input type="text" value="2"/> ▶ extension no. ▶ <input type="text" value="#"/> <b>Follow Me</b> <input type="text" value="7"/> ▶ your extension no. ] <b>Busy</b> <input type="text" value="3"/> ▶ extension no. ▶ <input type="text" value="#"/> <b>Follow Me Cancel</b> <input type="text" value="8"/> ▶ your extension no. ] <b>No answer</b> <input type="text" value="4"/> ▶ extension no. ▶ <input type="text" value="#"/> <b>Cancel</b> <input type="text" value="0"/> ] <b>Busy/No answer</b> <input type="text" value="5"/> ▶ extension no. ▶ <input type="text" value="#"/> ] (Check the type of your Main Unit.)
Clearing the setting	 ▶ [ <input type="text" value="7"/> <input type="text" value="9"/> <input type="text" value="#"/> <input type="checkbox"/> KX-TE Series ] [ <input type="text" value="*"/> <input type="text" value="7"/> <input type="text" value="9"/> <input type="text" value="0"/> <input type="checkbox"/> KX-TDA Series ] ▶  (Check the type of your Main Unit.)

# Features List

Desired Function	Operation
<b>Useful Features</b>	
Log-in/Log-out	<div style="border: 1px dashed black; padding: 10px;"> <p><input type="checkbox"/> KX-TE Series</p> <p>[ 7 3 6 0 # ] For Log-in</p> <p>[ 7 3 6 1 # ] For Log-out</p> <p><input type="checkbox"/> KX-TDA Series</p> <p>[ * 7 3 6 1 ] For Log-in</p> <p>[ * 7 3 6 0 ] For Log-out</p> <p>[ ICD Group* extension no. ] Specified</p> <p>[ * ] All</p> <p>* ICD Group: Incoming Call Distribution Group (Check the type of your Main Unit.)</p> </div>
Do Not Disturb (DND)	<p><input type="checkbox"/> KX-TE Series</p> <p> →  → [ 4 Set / 0 Cancel ] → # → </p> <p><input type="checkbox"/> KX-TDA Series</p> <p> → * 7 1 → [ 0 Both calls / 1 Outside calls / 2 Intercom calls ] → [ 1 Set / 0 Cancel ] → </p> <p>(Check the type of your Main Unit.)</p>
Locking your extension	<div style="border: 1px dashed black; padding: 10px;"> <p><input type="checkbox"/> KX-TE Series</p> <p>[ 7 7 lock code lock code ] → # Lock</p> <p>[ 7 7 lock code ] → # Unlock</p> <p><input type="checkbox"/> KX-TDA Series</p> <p>[ * 7 7 1 ] Lock</p> <p>[ * 7 7 0 ] → extension PIN* Unlock</p> <p>* PIN: Personal Identification Number (Check the type of your Main Unit.)</p> </div>

\* Consult your dealer for more details about the feature access numbers.

# Location of Controls

RINGER Volume Selector/  
 BACKLIGHT  
 Illumination Selector

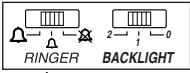

LCD (Liquid Crystal Display) with Backlight

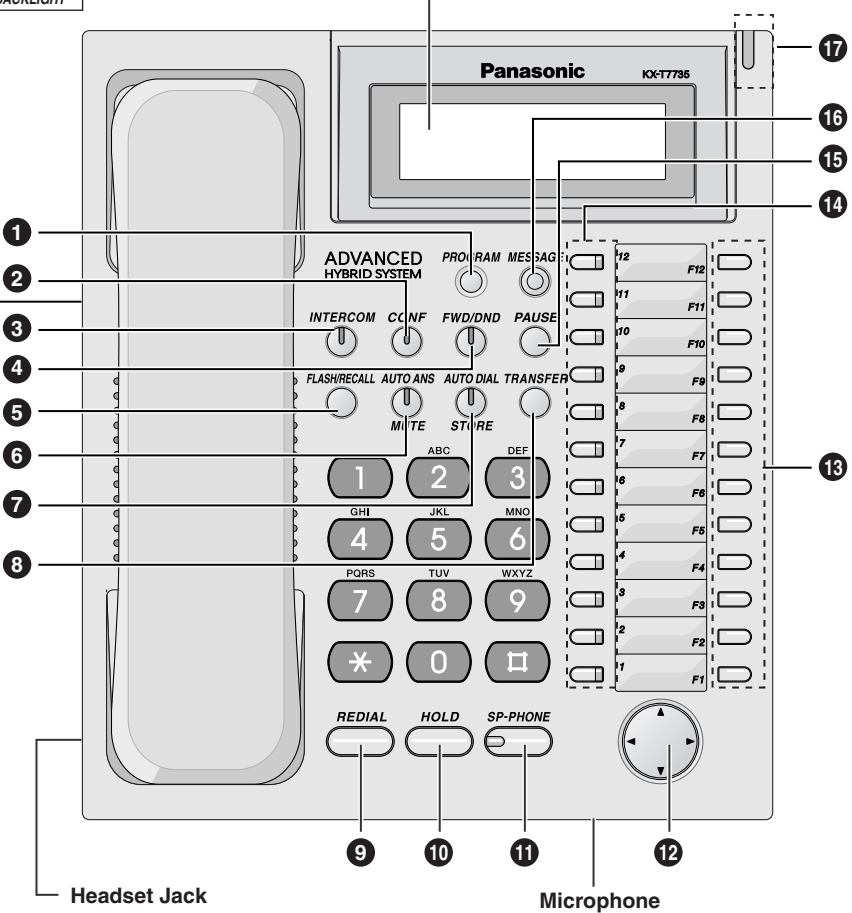

\* Headset (not included)  
 Not available: KX-T7090



# Location of Controls

---

- 1 **PROGRAM:** Used to enter and exit the programming mode.
- 2 **CONF (Conference):** Used to establish a multiple party conversation.
- 3 **INTERCOM:** Used to make or receive intercom calls.
- 4 **FWD/DND (Call Forwarding/Do Not Disturb):** Used to perform Call Forwarding or Do Not Disturb.
- 5 **FLASH/RECALL:** Used to disconnect the current call and make another call without hanging up.
- 6 **AUTO ANS (Auto Answer):** Used to receive an incoming call in the hands-free mode.  
**MUTE:** Used to mute the microphone during a conversation.
- 7 **AUTO DIAL/STORE:** Used for speed dialling or storing program changes.
- 8 **TRANSFER:** Used to transfer a call to another party.
- 9 **REDIAL:** Used to redial.
- 10 **HOLD:** Used to place a call on hold.
- 11 **SP-PHONE (Speaker Phone):** Used for the handsfree operation.
- 12 **Navigator Key:** Used to adjust the volume and the display contrast or select desired items for each function.
- 13 **Programmable Feature (PF) Button:** Used as an One-touch Dialling button (Button assignment is required).
- 14 **Flexible Outside (CO) Line Button:** Used to make or receive an outside call. Pressing this button seizes an idle outside line automatically. (Button assignment is required.) Also used as the desired function buttons. (Button assignment is required.)
- 15 **PAUSE:** Used to insert a pause during dialling.
- 16 **MESSAGE:** Used to leave a message waiting indication or call back the party who left the message waiting indication.
- 17 **Message/Ringer Lamp:** The Message/Ringer lamp informs you visually that you have a message or a call.
  - When you receive a call, the lamp flashes depending on the ringing pattern. When someone has left you a message, the lamp is lit continuously.
  - When the ringing pattern is set to Single (Slow flash), Double (Moderate flash), or Triple (Rapid flash) in your PABX, the lamp flashes. When the other ringing patterns are set in your PABX, the lamp may not flash (e.g., S-Double, Call Waiting Tone1).

# Initial Settings

## ◆ Speaker volume \*

While in on-hook or during a conversation



Press **SP-PHONE**.      Press **Up** or **Down**.

## ◆ Handset/Headset volume \*

While using a handset or headset



Press **Up** or **Down**.

## ◆ Ringer volume/Backlight illumination

While in on-hook or receiving a call

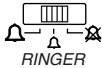

Slide the lever of the **RINGER** Volume Selector to the desired setting (**HIGH/LOW/OFF**).



Slide the lever of the **BACKLIGHT** Illumination Selector to the desired setting.

BACKLIGHT sw position	2	1	0
LCD backlight	HIGH	LOW	OFF

## ◆ Display contrast \*

While in on-hook or receiving a call



Press **Left** or **Right**.

\* The above settings may return to default settings if the telephone line cord is disconnected or the main unit's power is interrupted.

# Connection

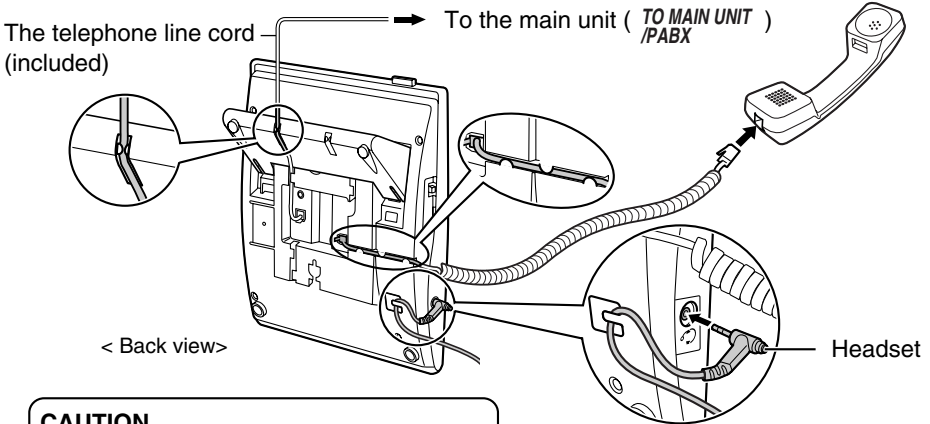

**CAUTION**  
Ensure the cord is inserted in the groove to prevent damage to the connector.

# Wall Mounting

**1** Pull down the handset hook until it locks, so the tab holds the handset.

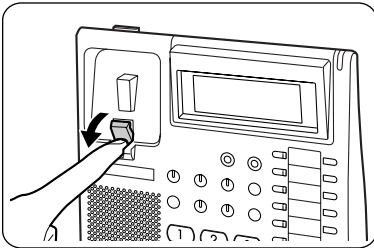

**3** Mount the unit on the wall.

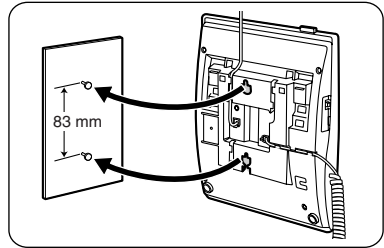

**2** Remove the attached stand.

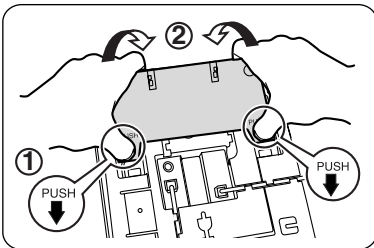

**To temporarily place the handset down during a conversation,** hook it over the top edge of the phone as shown.

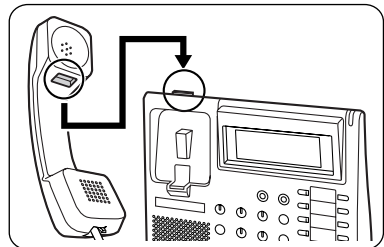

# Tilt Angle

The tilt angle of the unit can be adjusted.  
**To adjust the angle**, attach the stand in the desired position.

<LOW>

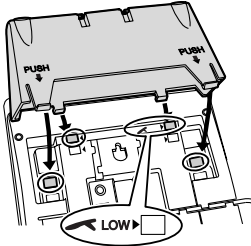
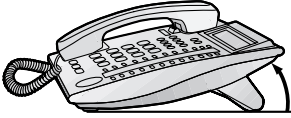

<HIGH>

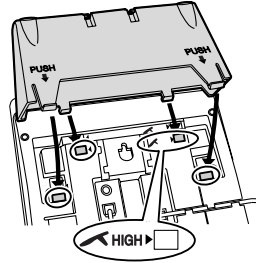
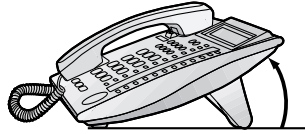

## Included Accessories

Accessory	Qty	White Model	Black Model
Handset	1	PQJX2PSL01Z	PQJX2PKAL01Z
Handset Cord	1	PSJA1084Z	PSJA1084X
Telephone Line Cord	1	PSJA1064Z	PSJA1064Z
Stand	1	PSYL1004Z1	PSYL1004Z2
Overlay	1	PSGD1066Z	PSGD1066Z



This product is intended to be connected to Panasonic KX series PABX only. Panasonic Communications Company (U.K.) Ltd. declares that this equipment is in compliance with the essential requirements and other relevant provisions of Radio & Telecommunications Terminal Equipment (R&TTE) Directive 1999/5/EC. Declarations of Conformity for the relevant Panasonic products described in this manual are available for download by visiting: <http://www.doc.panasonic.de>

Contact:  
 Panasonic Services Europe  
 a Division of Panasonic Marketing Europe GmbH  
 Panasonic Testing Centre  
 Winsbergring 15, 22525 Hamburg, Germany

### Panasonic Business Systems U.K.

Panasonic House, Willoughby Road, Bracknell, Berkshire RG12 8FP

© 2004 Panasonic Communications Co., Ltd. All Rights Reserved.

**PSQW2304YA** KU1204TN1046(E)